



wissner-
bosserhoff

estetica nova

Furniture for an ambience worth living in



“When it comes down to it,
people have only two wishes:
to grow old, while staying young.”

Peter Bamm

Knowledge concerning our growing life expectancy increasingly changes our awareness of the older generation. We are confronted with a transformation in values, which has new and exciting tasks in store. To meet the new culture of the aged the quality of life of the elderly, especially those in need of care, needs to be raised to a new level.

wissner-bosserhoff pursues a clearly defined objective: To support the desires and needs of people in intensive care with innovative and functional products. A claim that is fully justified by the nursing home bed estetica nova. Because as a synthesis of high safety requirements and individual nursing care comfort, estetica nova stands for professional and civilised handling of people in need of nursing care.

estetica nova S 10





01



02

Previous page Nursing home bed estetica nova S10 in maple, with bedside cabinet stylo C3.

01 The foot section S combines wood and steel in a modern design.

02 The side protection that can be pulled out up to 40 cm provide an individual safeguard and maximum freedom of movement.

Right page Bedside cabinet stylo C3 in maple, with height-adjustable overbed table.



“It takes a long time for you to become young.”

Pablo Picasso

estetica nova S 10 is the combination of homeliness and individual nursing comfort – even for levels of intensive care. The bed provides numerous practical functions. Apart from its movability in every bedding position and an easy to operate brake, estetica nova meets the specifications of the expert standard “Fall Prevention”. The partitioned side protection (zero gap) support the mobility of the occupant and close without a gap. The matching bedside cabinet stylo C3 – awarded the red dot design prize – additionally meets the needs of the occupant with individual comfort.

estetica nova S 10



estetica nova G 09





01

Previous page Nursing home bed estetica nova G09 in walnut and bedside cabinet vivo E2 with stylo server S3.
01 Be on the safe side with a continuous side protection and easy-running trigger release.
02 Nursing home bed estetica nova K 09 in walnut and bedside cabinet E2 with server stylo S3.
Page right The combination of bedside cabinet and server, which can be stored away to save space when not used, is particularly economical.



02



The nursing home bed estetica nova G09 or K09 in walnut fits harmonically into a homelike atmosphere. Through the double retraction of backrest and foot rest, residents up to 180 cm in height do not need any lying surface extensions that take up space. The bed, manufactured entirely in Germany, is equipped with lifting columns made by wissner-bosserhoff which guarantee a safe working load of up to 200 kg. With the matching bedside cabinet vivo E2, the surroundings have a generous and uniform appearance. Practical: the serving tray, which is simply pushed up to the bed.

“Getting old means learning to see.”

Marie von Ebner-Eschenbach

estetica nova G 09



nursing home bed estetica nova

Individual nursing comfort through a wide variety of functions.

03 Patient surface

For healthy lying with Comfort:

- Double retraction of the backrest (11 cm) and leg rest (6 cm) for bedsore prevention
- Prepared patient surface extension
- Removable partitions ensure ease of cleaning
- Free choice of mattresses
- Optimal aeration of mattresses
- Comfort cushioning technology (optional) for an additional soft lying effect, orientation zone for support when sitting and for orientation when asleep

02 Handset

estetica nova beds stand out because they are easy to operate:

- Clear and ergonomic handset
- Handset and control box in one
- Automatic comfort seating
- Automatic prevention for decongestion for venous diseases and for bedsore prevention according to Fowler (semi-Fowler 30° lying position)

01 Side protection

The innovative safety concept provides significant advantages:

- Seamless "zero gap" safety without further accessories
- Can be used as an aid for mobilisation and getting up
- Fall prevention in accordance with the expert standard "Fall Prevention" is possible**
- Adjustable at four different heights
- Safe use of patient restraint systems in accordance with the BfArM*

05 Movability and braking capacity

Brakes can be applied to all 4 castors through the central brake, via foot operation:

- Mains-independent braking and moving
- Operation at any bedding height, reducing back strain
- Time-consuming procedure in low position unnecessary
- Good movability due to 100/125 mm castors with directional castors

04 Lifting technology

estetica nova beds stand out due to their sturdy lifting column construction:

- height adjustment from 42-82 cm (with 100 mm castors)
- 200 kg safe working load
- Underbed clearance for all patient lifters
- Feet are free to simplify nursing care
- Closed system, thus very easy to disinfect



side protection

Innovation

Release 10

Cosiness 1st level: For a side protection in the starting position, the estetica nova bed has a particularly cosy effect.



Barrier-free protection
2nd level: The side protection is used as a barrier-free protection and for the orientation of the resident.



Protection and freedom
(day position) 3rd level, head end: The graduated position of the side protection provides safety without restricting the resident in his freedom of movement – adjustable for bed egress to the left or right.



Seamless safety (Zero Gap) with 12 cm mattress (night position)
3rd level: For seamless safety when using 12cm high mattresses.



Seamless safety (Zero Gap) with 18 cm mattress 4th level: Full safety is guaranteed even when using active systems up to 18 cm in height.



estetica nova beds prove themselves with a safety concept that does full justice to the requirements of residents and nursing staff. The estetica nova, with its divided side protection (zero gap) meets the high requirements of the expert standard "Fall Prevention". Side protection attached at the head end support the mobilisation of the resident, at the same time contributing to his/her safety. In the top position, the two parts of the side protection close together so

Tradition

Release 09/06

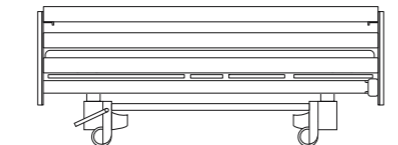
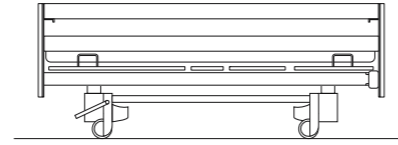
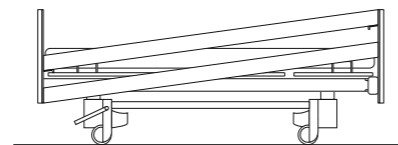
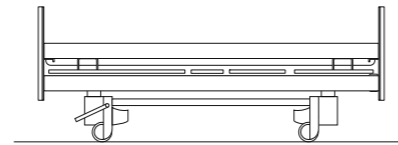
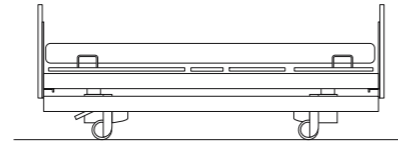

tightly that they are just as safe as a continuous side rail. This makes the estetica nova suitable for all levels of care, as well as for the use of restraining belts. In the fourth extension level, the estetica nova is also suitable for the use of special mattresses up to 18 cm in height. At the customer's request, the nursing home bed is of course available with a continuous side protection.

mobility

Saving time Because of the movability and braking capacity of the bed in every lying position, no time-consuming returning to the starting position is required.

Ease of nursing care
Thanks to the large directional castors, the bed can be moved effortlessly and economically by just one person.

Central brake To simplify daily nursing care, estetica nova provides three different settings for braking and moving: The braked position, free-wheeling, and directional castors. These positions can be adjusted effortlessly via the easily accessible central brake.

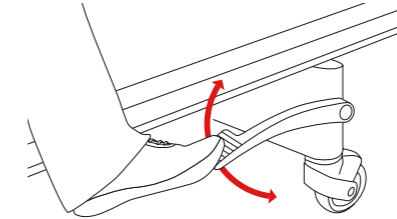

Underbed clearance
The undercarriage, lying on the outside, enables a convenient underbed clearance of the estetica nova for all commercially available patient lifters.

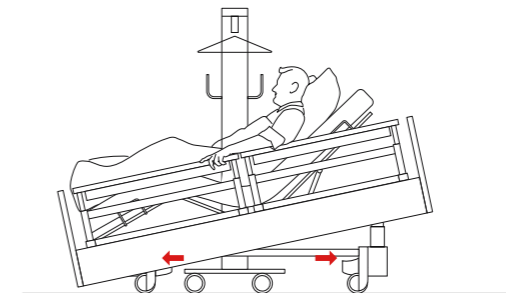

Stability and load capacity Thanks to the robust lifting column construction, the bed can cope with loads of up to 200 kg, even in the highest position. The lifting column elements produced by wissner-bosserhoff each have a shift force of 2000 N and have been tried and tested in practise worldwide over 60,000 times. Even when swivelled, the lifting columns remain straight, enabling the bed to be moved without problem. The lifting column elements, as closed system, are maintenance-free and easy to clean, thus incurring only minimal operating costs.

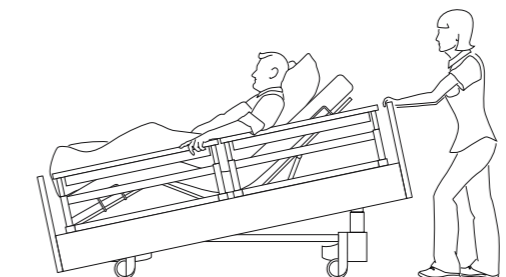

Unique lifting column construction In contrast to other lifting mechanisms, the lifting column units of the estetica nova have no joint or bolted connections which could be penetrated by contaminated liquid or make cleaning more difficult. Through the electrolytic oxidation of the lifting columns and the permanent thin layer of lubricant, the lifting columns provide only a minimal adhesion for contaminating fluids. Contaminants only have weak adhesion, and even after drying out they can be removed without problem.



2000 N = 200kg for each lifting column

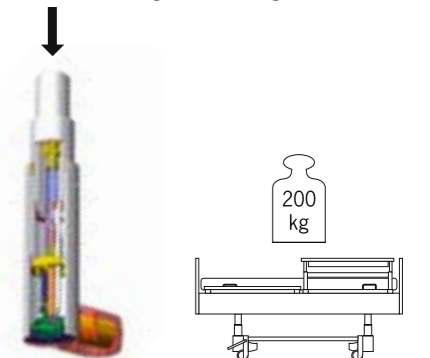

patient surfaces

1

Physiological posture

A back rest with a length of at least 80 cm is an indispensable prerequisite for a physiological posture in bed. This reduces shearing forces, and breathing is helped by the natural bending in the area of the hips. In addition the head is supported safely.

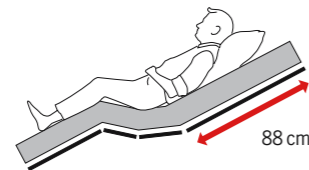

2

Double retraction

The double retraction of backrests (11 cm) and leg rests (6 cm) helps to reduce pressure in the pelvic area and cut down friction and shearing forces. The risk of bedsores is reduced. In addition, 17 cm more space is created in the bed and in the room – residents up to 180 cm in size do not require any patient surface extension that would take up space.

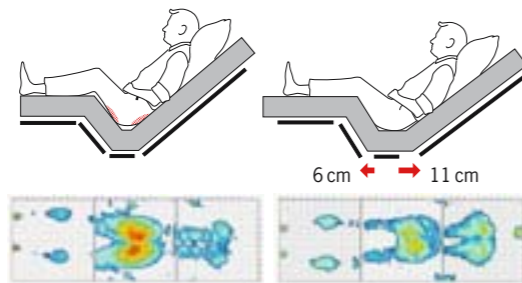

Standard patient surface

Double retraction – 17 cm more space in the bed

Many residents are forced to spend a large part of their time in bed. Lying correctly and comfortably is very important in supporting the health of the resident as well as possible. estetica nova beds provide patient surfaces standing for effective bedsores prevention. The retraction of the backrest recommended by the DBfK is supplemented by a retraction of the leg rest, thus creating 17 cm more space in the bed. Since residents up to 180 cm in height do not require any patient surface extension, more space is created in the room at the same time.

3

Free choice of mattresses

The system allows the effective use of all commercially available foam and air cell systems up to 18 cm in height.



4

Free choice of patient surface

01 Aero – the wire mesh patient surface ensures good aeration.

02 Easyclean – the synthetic padding is particularly easy to clean.

02 Comfort – the Comfort patient surface, with its outstanding soft lying properties, provides an effective bedsores prevention. The patient surface partitions can be removed for ease of cleaning. The elements on the edges, with reinforced springs, are used as an orientation when sitting and while asleep.

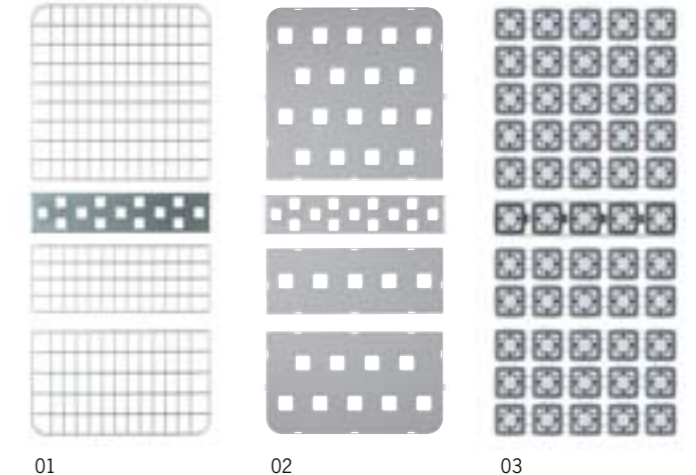
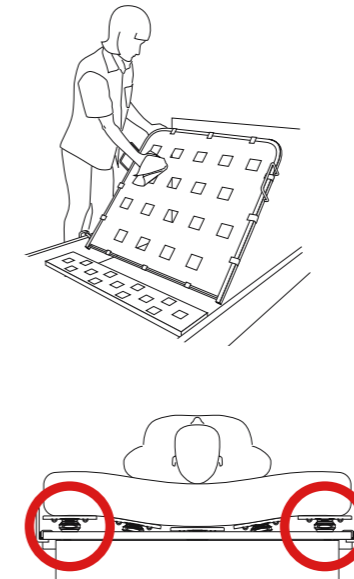

01

02

03

5

Integrated preparation for the patient surface extension

With the patient surface extension prepared as standard, the nursing home bed can be adjusted quickly and easily for larger patients over 180 cm in height. Two different types of patient surface extension are optionally available – a temporary extension of the bed (only for divided side protection) or a permanent extension of the patient surface.



lying and mobilisation

Nursing-friendly bed adjustment The preset automatic functions in the handset are easy to operate.

Clarity and safety: The advantages of the handset:

- Clearly structured, few buttons
- Initial-fault tolerance through preselection – no triggering of function by accidentally pressing a button
- ergonomic design – no unintended operation of buttons
- 2-in-1 safety package: Handset and control box in one on the rear of the handset
- Magnet-free key for mechanical adjustment of the three handset modes:

01 Locking mode – all functions of handset are locked

02 Resident mode – the top 3 selection buttons are available to the resident. (based on DIN EN 1970 with the requirements for handicapped people without medical supervision)

03 Nursing care mode – all section buttons are available (based on DIN EN 60601-2-38 with the requirements for sick people with medical supervision)

Automatic comfort seating The automatic comfort seating moves the bed to the preset sitting position: convenient for watching television or reading, for eating or communicating at eye level. Mobilisation using the lifter is effectively supported in this position.

Automatic prevention Supports decongestion with venous diseases and at the same time encourages bedsore prevention (semi-Fowler 30° lying position). www.decubitus.be

Reset function After selecting comfort seating or automatic prevention, followed by a downward movement, all lying position adjustments are automatically returned to the zero position.



bedside cabinet and server

The bedside cabinets **stylo**, **vivo** and **vt1** transform the estetica nova into a cosy unit: with rounded edge profiles and an elegant, modern design. At the same time the bedside cabinets provide a large amount of storage space and individual comfort in many everyday situations – from eating to reading. The use of drawers instead of doors simplifies access from the bed, thus contributing to effective fall prevention. In addition, nursing staff benefit from the ease of handling the bedside cabinets.



The bedside cabinets **vivo** and **stylo** are also available with an integrated overbed pull-out tray. The **vt1** includes an integrated pull-out tray.

The modern overbed pull-out tray not only has won two awards for its design, it also excels through its particular practicability; nursing staff can operate both the pull-out tray and the height adjustment without having to put down the tray first. Additional benefit: The resident can comfortably put the overbed table into the correct position from the bed.

The combination of the bedside cabinets **vivo E2**, **stylo C2** and **vt1** with the server **stylo S3** is particularly economical, since both products can be used in different rooms, independent of one another. If the server is not needed, it is placed in a parked position behind the bedside cabinet, so that it is always in a braked position.

Through its u-shaped undercarriage the server can be used in combination with arm rest, transport- and wheelchair – and can also be used as a replacement table.

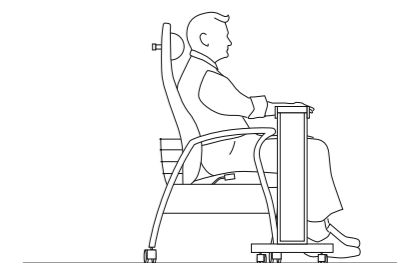
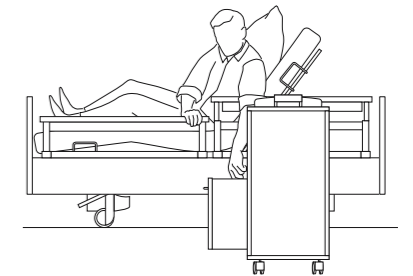

range overview

Side protection

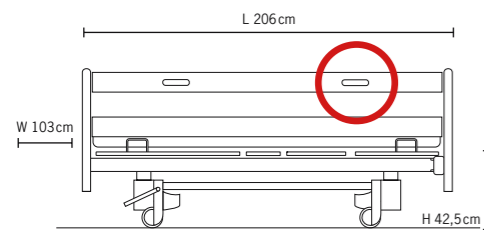

06 (recessed grip release) continuous two-piece side protection with central lowering device L 206 cm, W 103 cm, H 42.5 cm (up to patient surface)

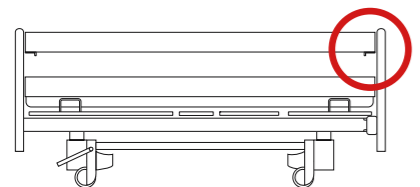

09 (trigger release) continuous two-piece side protection with external lowering device L 206 cm, W 103 cm, H 42.5 cm (up to patient surface)

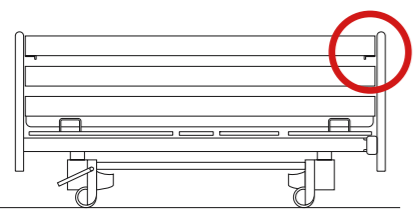

09 (trigger release) continuous three-piece side protection with external lowering device L 206 cm, W 103 cm, H 42.5 cm (up to patient surface)

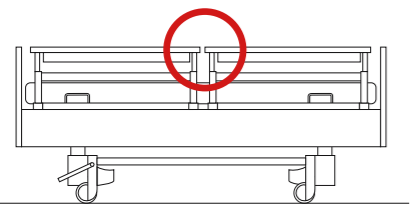

10 divided side protection, "zero gap", seamless L 206 cm, W 106 cm, H 42.5 cm (up to patient surface)

Head and foot ends

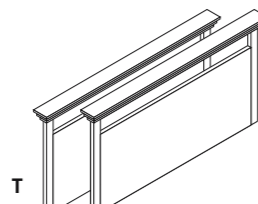
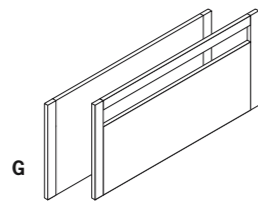
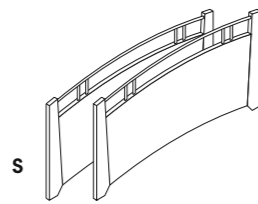
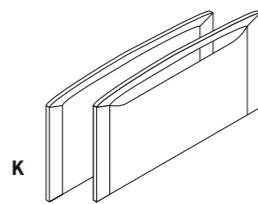

Castors

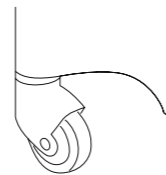

Easy-roll castor Tente Decora
Diameter 100 mm

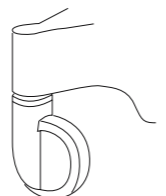

Easy-roll castor Tente Integral
Diameter 125 mm

Lying systems

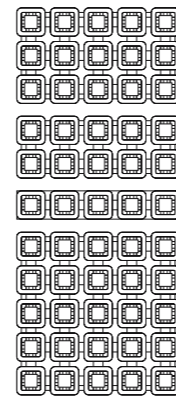

Komfort

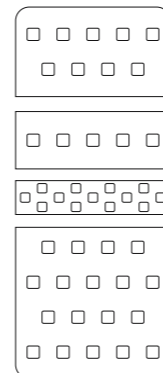

Easyclean

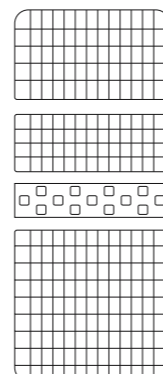

Aero

Bedside cabinet and server

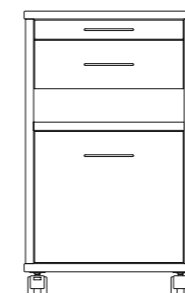

10-0368 Bedside cabinet vt1

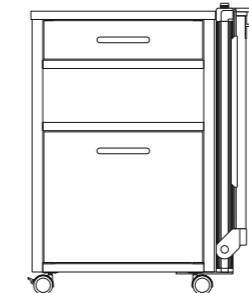

10-0283 Bedside cabinet vivo E3 with integrated overbed table pull-out tray
10-0324 Bedside cabinet vivo E2 without integrated overbed table pull-out tray (no picture)

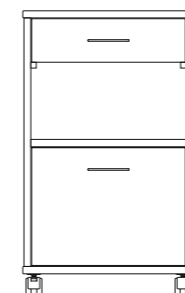

10-0330 Bedside cabinet vt2
10-0498 Bedside cabinet vt2K with preparation for refrigerator (no picture)

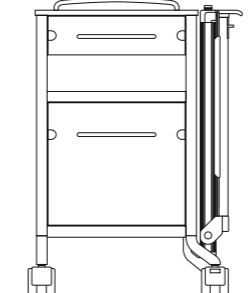

10-0271 Bedside cabinet stylo C3 with integrated overbed pull-out tray
10-0327 Bedside cabinet stylo C3K with integrated overbed pull-out tray and refrigerator (no picture)
10-0193 Bedside cabinet stylo C2
10-0298 Bedside cabinet stylo C2K with integrated refrigerator (no picture)

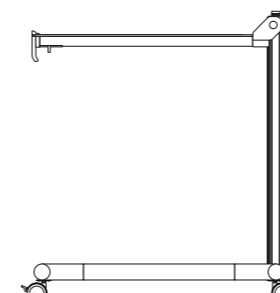

10-0273 Server stylo S3 with overbed table that can be lowered for combination with bedside cabinet without integrated overbed table mechanism

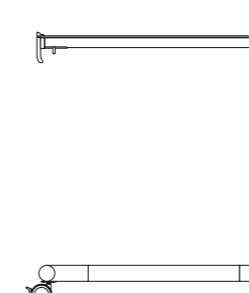

10-0400 Server stylo S3T with overbed table that can be lowered, as well as additional storage tray

Options / Accessories

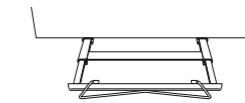

Linen holder



Wall stopper castors

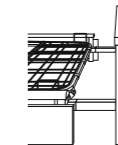

Bed extension Type A side protection 10

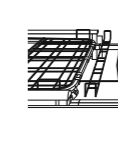

Bed extension Type B side protection 10

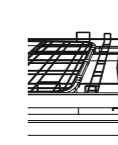

Bed extension Type B side protection 06/09

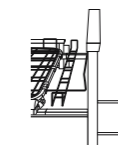

10-0473 Head end wall stopper bracket

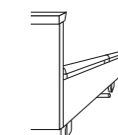

10-0475 Side wall spacer

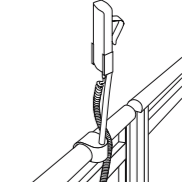

10-0419 Adapter Handset holder for **divided** side protection 10 (zero gap)
10-0421 Handset holder, short

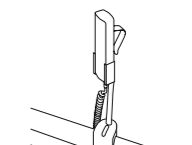

10-0422 Accessory and handset socket for continuous side protection 09/06
10-0421 Handset holder, short

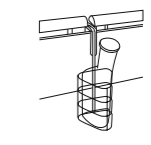

10-0424 Accessory and handset socket to attach to the side panel for divided side protection
50-0165 Urine bottle holder
50-0164 Urine bag holder (no picture)



Safety: The quality and safety management works in accordance with the regulations DIN EN ISO 9001:2000 and DIN EN ISO 13485:2003, our beds carry the CE mark. 3 year factory guarantee.

Our recommendation: Expert standard "Fall Prophylaxis" (cf. Expert standard Fall Prophylaxis dated Feb. 2005, Chap. 2.6.2.7., p. 71/72 Information can be found at www.dnqp.de)

K02 cherry R 5360
Bed panelling, undercarriage cover

B01 beech, tinted R 5313
Bed panelling, undercarriage cover

B00 natural beech R 5320
Bed panelling, undercarriage cover

A03 maple R 5184
Bed panelling, undercarriage cover

E04 alder, golden red R 4601
Bed panelling, undercarriage cover

N05 walnut R 4801
Bed panelling

Silver-grey, similar to RAL 7001
Undercarriage cover

Concept and Design
sieger design

Photography
Studio Casa & René Schwerdtel

Print
msp druck und medien

Edition
12/2007, Rev.1, Art.-No.: 97-0451
wissner-bosserhoff

Slight deviations in colour are possible.
Technical changes reserved.

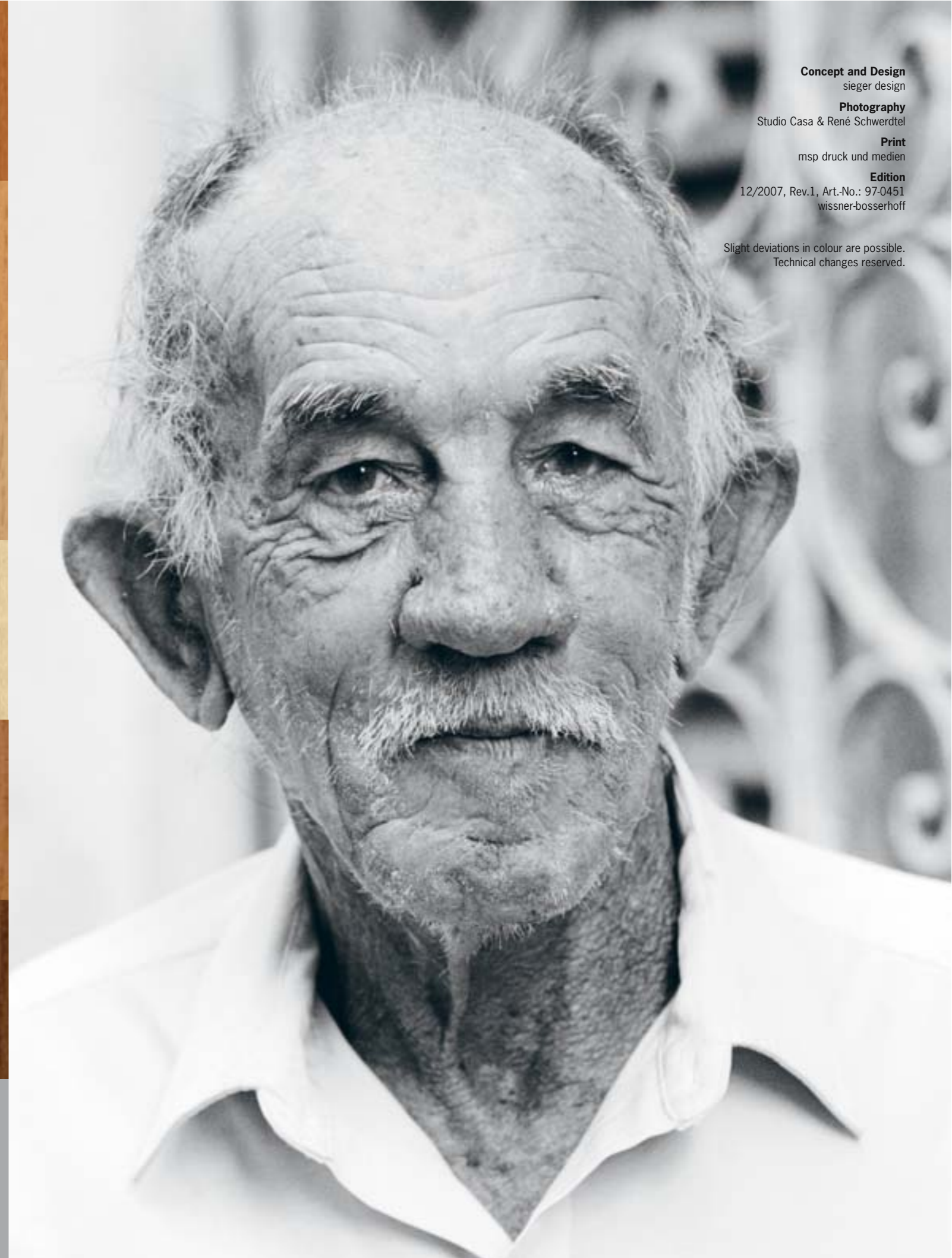



wissner- bosserhoff

Furniture for an ambience worth living in

wissner-bosserhoff GmbH
Hauptstraße 4-6
D-58739 Wickede (Ruhr)
Phone: +49 (0) 23 77 / 784-0
Fax: +49 (0) 23 77 / 784-163
E-Mail: info@wi-bo.de

www.wi-bo.com

Made in Germany



TEPREL - Equipamentos Médicos, S.A.
Rua D. Marcos da Cruz, 1997 - 1º Poente
4455-482 Perafita | Portugal
Tel +351 229 999 880 | Fax +351 229 999 889
info@teprel.com | www.teprel.com

